

DE PRODUKTE
FR PRODUITS

EN PRODUCTS
ES PRODUCTOS

IT PRODOTTI

A... / MOTOR

Fußbefestigung / Foot mounting / Fissaggio piede /
Fixation à pattes / Fijación por patas

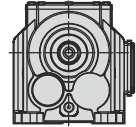
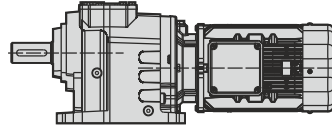

A... / PAM

Fußbefestigung / Foot mounting / Fissaggio piede /
Fixation à pattes / Fijación por patas

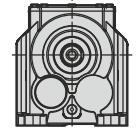
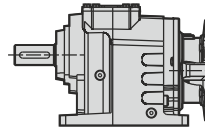

A... / W

Fußbefestigung / Foot mounting / Fissaggio piede /
Fixation à pattes / Fijación por patas

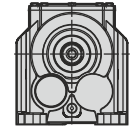
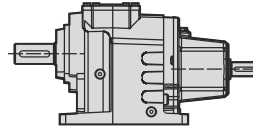

F... / MOTOR

Flanschbefestigung / Flange mounting / Fissaggio flangia /
Fixation à bride / Fijación por brida

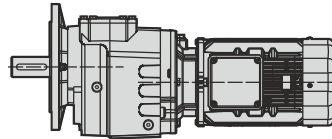

F... / PAM

Flanschbefestigung / Flange mounting / Fissaggio flangia /
Fixation à bride / Fijación por brida

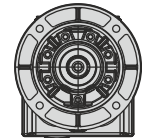
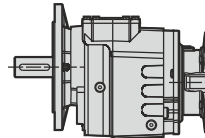

F... / W

Flanschbefestigung / Flange mounting / Fissaggio flangia /
Fixation à bride / Fijación por brida

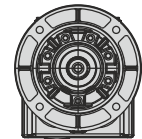
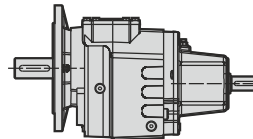

AF... / MOTOR

Fuß-Flanschbefestigung / Foot-flange mounting / Fissaggio piede-flangia
Fixation à paaes et bride / Fijación patas-brida

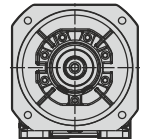
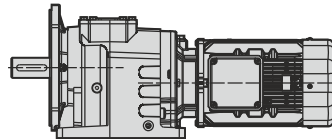

AF... / PAM

Fuß-Flanschbefestigung / Foot-flange mounting / Fissaggio piede-flangia
Fixation à paaes et bride / Fijación patas-brida

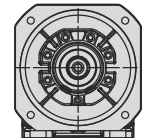
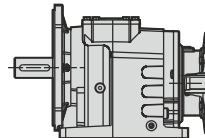

AF... / W

Fuß-Flanschbefestigung / Foot-flange mounting / Fissaggio piede-flangia
Fixation à paaes et bride / Fijación patas-brida

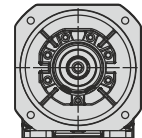
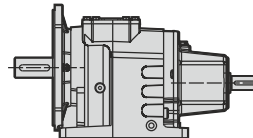

Typ / Type / Tipo Type / Tipo	I _{ges}	4-pol 50Hz 1400rpm n ₂ [min ⁻¹]	M _{amax} f _B =1 4 - pol. [Nm]	W			IEC - PAM									
				P _{1max} 4 - pol. 1400 rpm [kW]	FR1 [kN]	FR2 (a) [kN]	f _B ⇨ 49 - 112									
A603 F603 W 139 + PAM - IEC 139	242.67	5.8	3600	2.17	4.0	22.0	90	100*	112*	132*						
	215.56	6.5	3500	2.38	4.0	22.0	90	100*	112*	132*						
	194.31	7.2	3500	2.64	4.0	22.0	90	100*	112*	132*						
	181.13	7.7	3500	2.83	4.0	22.0	90	100*	112*	132*						
	160.90	8.7	3500	3.19	3.9	22.0	90	100	112*	132*						
	143.57	9.8	3500	3.57	3.9	22.0	90	100	112*	132*						
	PAM - IEC	134.25	10.4	3500	3.82	3.9	22.0		100	112*	132*	160*				
	121.02	11.6	3500	4.24	3.9	22.0		100	112*	132*	160*					
	100.21	14.0	3500	5.12	3.9	22.0		100	112	132*	160*					
	93.60	15.0	3500	5.48	3.8	22.0		100	112	132*	160*					
	84.37	16.6	3500	6.08	3.8	22.0		100	112	132*	160*					
	79.98	17.5	3500	6.42	3.8	22.0		100	112	132*	160*					
	69.87	20.0	3500	7.34	3.7	22.0		100	112	132*	160*					
	55.75	25.1	3500	9.20	3.7	22.0				132	160*					
	A602 F602 W 139 + PAM - IEC 139	50.91	27.5	3300	9.50	3.6	22.0	100	112	132						
45.27		30.9	3300	10.69	3.6	22.0	100	112	132	160*						
40.81		34.3	3300	11.85	3.5	21.7	100	112	132	160*						
38.00		36.8	2800	10.80	3.6	22.0	100	112	132							
33.79		41.4	3200	13.88	3.4	20.0	100	112	132	160*						
30.35		46.1	3200	15.46	3.4	18.9	100	112	132	160						
PAM - IEC		28.36	49.4	3300	17.06	3.3	17.8	100	112	132	160	180*				
25.57		54.8	3300	18.92	3.2	16.8	100	112	132	160	180*					
23.66		59.2	3300	20.45	3.1	16.1	100	112	132	160	180*					
21.17		66.1	3200	22.16	3.1	15.4	100	112	132	160	180					
19.59		71.5	3200	23.94	3.0	14.7	100	112	132	160	180					
17.60		79.5	3200	26.65	2.9	13.8	100	112	132	160	180					
15.87		88.2	3200	29.56	2.7	12.9	100	112	132	160	180					
13.14		106.5	3100	34.59	2.5	11.8	100	112	132	160	180					
10.91		128.3	3000	40.31	2.2	10.8			132	160	180					
9.83		142.4	2800	41.74	2.2	10.8			132	160	180					
8.14		171.9	2500	45.01	2.0	10.6			132	160	180					
6.92		202.4	2300	48.74	1.8	10.4			132	160	180					
6.24	224.5	2000	47.02	1.9	10.9			132	160	180						
5.16	271.1	1800	51.10	1.7	10.5			132	160	180						
A601 F601 W 136 + PAM - IEC 136	8.30	168.7	650	11.48	3.4	5.0	100	112	132	160*						
	7.45	187.8	650	12.78	3.4	5.0	100	112	132	160*						
	6.15	227.5	640	15.25	3.3	4.9	100	112	132	160						
	5.20	269.2	620	17.48	3.1	4.6	100	112	132	160	180*					
	4.81	290.9	620	18.89	3.1	4.4	100	112	132	160	180*					
	4.28	327.3	610	20.90	3.0	4.2			132	160	180*					
	PAM - IEC	3.65	383.6	600	24.10	2.8	3.9	100	112	132	160	180				
	3.23	433.8	600	27.25	2.7	3.7	100	112	132	160	180					
	2.44	572.7	550	32.98	2.4	3.4			132	160	180					
	2.00	700.0	450	32.98	2.4	3.3			132	160	180					
	1.38	1011.1	450	47.64	1.7	2.8			132	160	180					
1.27	1103.8	400	46.23	1.8	2.8			132	160	180						

- Keine IEC - PAM-Verbindung / No IEC - PAM assembling on empty fields / Nessun assemblaggio IEC - PAM su campi vuoti / Pas d'assemblage IEC - PAM sur champs vides / Sin montaje IEC - PAM en campos vacios
- 63 IEC - PAM-Verbindung möglich / IEC - PAM assembling available on numbered fields / Montaggio IEC - PAM disponibile su campi numerati / Assemblage IEC - PAM disponible sur champs numérotés / Assemblage IEC - PAM disponible sur champs numérotés /
- 80* Bei IEC - PAM-Verbindungen, sollten die P_{1max}-Werte nicht überschritten werden / Do not exceed the P_{1max} values indicated on fields with asterisk / Non superare i valori P_{1max} indicati sui campi con l'asterisco / Ne pas dépasser les valeurs P_{1max} indiquées sur les champs avec astérisque / No exceda los valores de P_{1max} indicados en los campos con asterisco

A 602 - 603

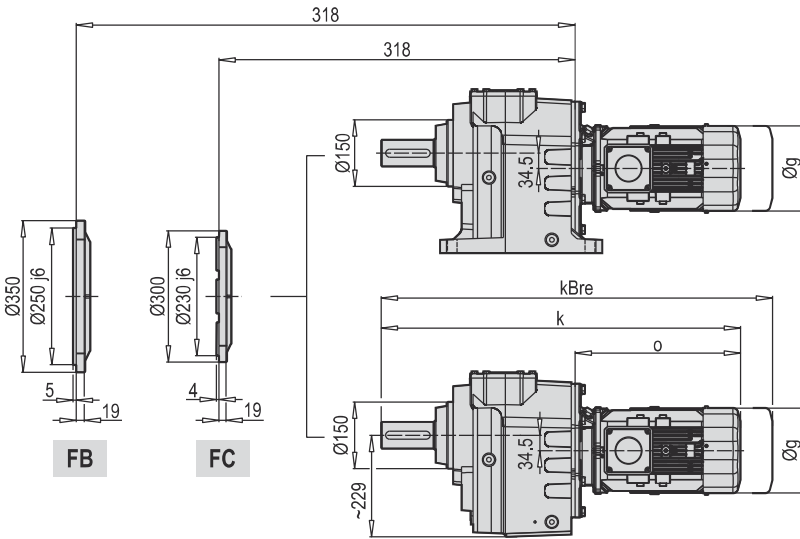
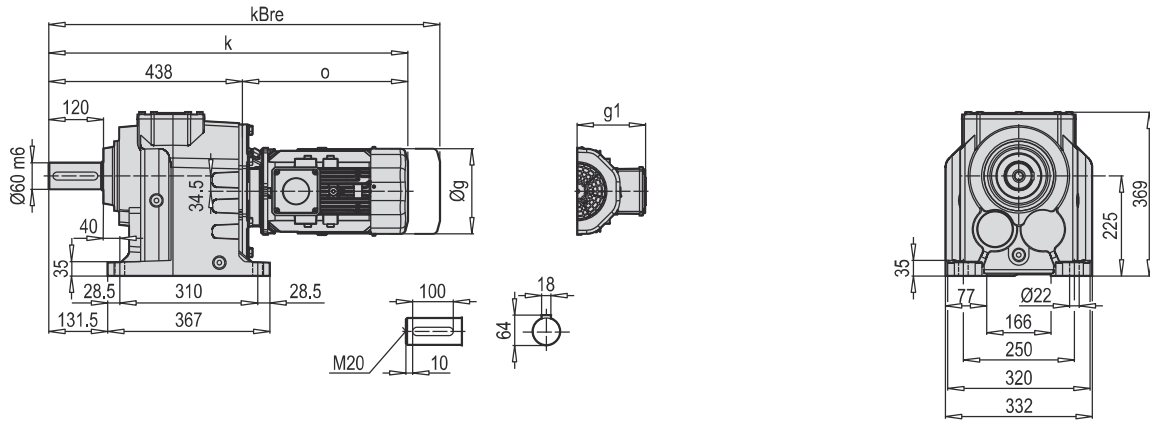

AF 602 - 603

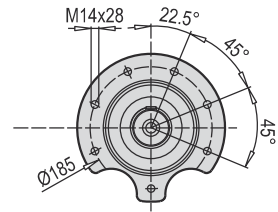

F 602 - 603

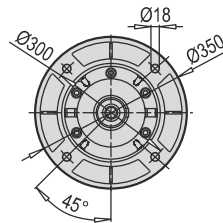
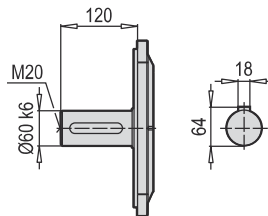

FB

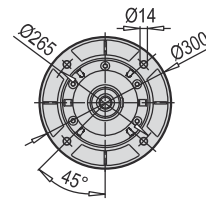

FC

	90 S/L	100 L	112 M	132 S	132 M	160 M/L	180 M/L
g	182	202	220	271	271	322	363
g1	130	153	159	188	188	214	249
k	757	811	809	882	882	963	1053
kBre	825	894	909	982	1002	1068	1172
o	319	373	371	444	444	525	615

A 602-603 PAM B5/B14

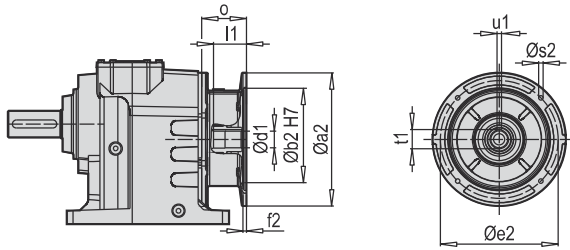

A 602-603 W

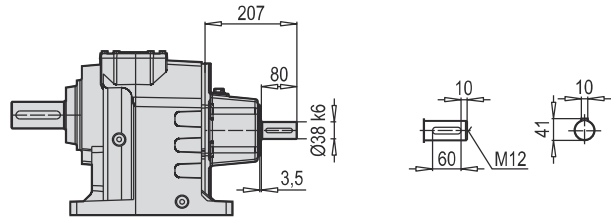

F 602-603 PAM B5/B14

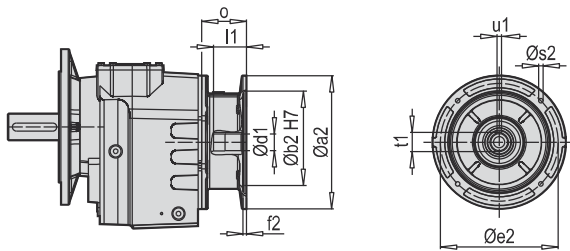

F 602-603 W

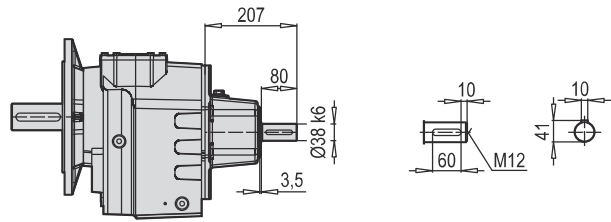

AF 602-603 PAM B5/B14

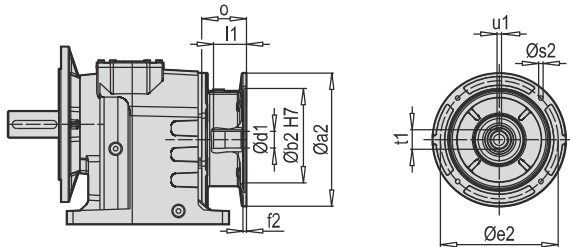

AF 602-603 W

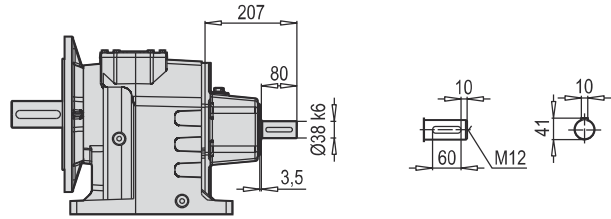

W ~ Kg	
A/F 602-603	90

Typ / Type / Tipo Type / Tipo	~ Kg										
	PAM B5	Øa2	Øb2	Øe2	f2	Øs2	Ød1	l1	t1	u1	o
A/F 602 A/F 603	90	200	130	165	5	M10	24	52	27.3	8	61
	100	250	180	215	5.5	M12	28	62	31.3	8	76
	112	250	180	215	5.5	M12	28	62	31.3	8	76
	132	300	230	265	5.5	M12	38	82	41.3	10	101
	160	350	250	300	7	M16	42	112	45.3	12	148
	180	350	250	300	7	M16	48	112	51.8	14	148

~ Kg	
PAM B5	A/F 602-603
90	81
100	85
112	85
132	88
160	94
180	94

Typ / Type / Tipo Type / Tipo	~ Kg										
	PAM B14	Øa2	Øb2	Øe2	f2	Øs2	Ød1	l1	t1	u1	o
A/F 602 A/F 603	90	140	95	115	3	9	24	52	27.3	8	61
	100	160	110	130	3.5	9	28	62	31.3	8	76
	112	160	110	130	3.5	9	28	62	31.3	8	76
	132	200	130	165	3.5	11	38	82	41.3	10	101

~ Kg	
PAM B14	A/F 602-603
90	78
100	80
112	80
132	86

DE ALLGEMEINE TEILELISTE

EN GENERAL PART LIST

IT GENERALE ELENCO DELLE PARTI

FR GÉNÉRALE LA LISTE DES PIÈCES

ES LISTE DE PIEZAS EN GENERAL

A / F / AF 252 ... 902

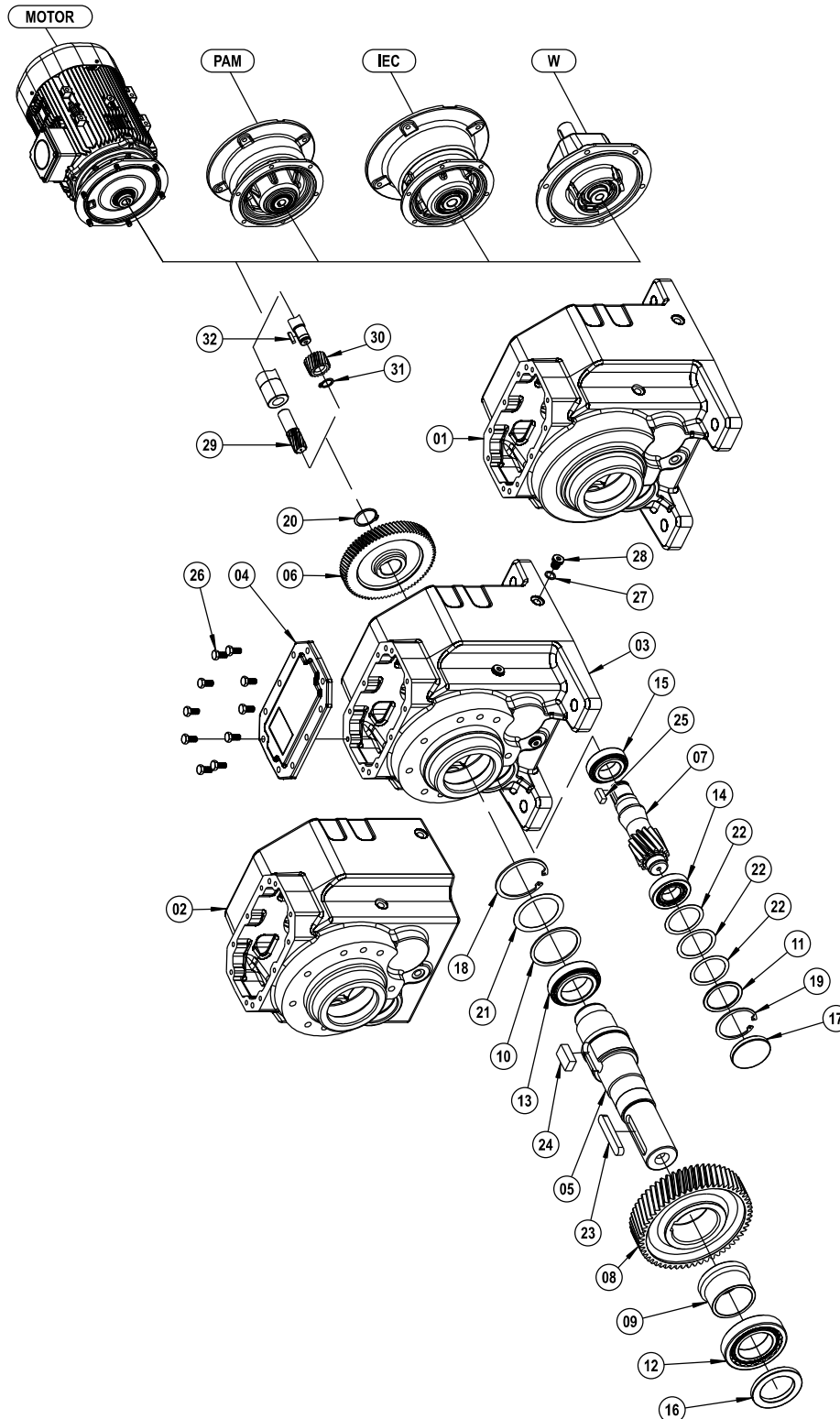

DE

ALLGEMEINE TEILELISTE

EN

GENERAL PART LIST

IT

GENERALE ELENCO DELLE PARTI

FR

GÉNÉRALE LA LISTE DES PIÈCES

ES

LISTE DE PIEZAS EN GENERAL

01 A Gehäuse	A Gear Case	A Ingranaggi Box	A Corps	A La caja de engranajes
02 F Gehäuse	FGear Case	F Ingranaggi Box	F Corps	F La caja de engranajes
03 AF Gehäuse	AF Gear Case	AF Ingranaggi Box	AF Corps	AF La caja de engranajes
04 Abdeckung	Cover	Coperchio	Couverture	Cubierta
05 Abtriebswelle	Output Solid Shaft	Albero di uscita	Arbre de sortie	Eje de salida
06 Antriebsrad	Driving Gear	Ingranaggio Conduttore	Rove d'entrée	Engranaje con ducido
07 Ritzelwelle	Pinion Shaft	Pignone	Arbre intermédiaire	Deleje del piñón
08 Abtriebsrad	Driven Gear	Ingranaggio Condotto	Rove de sortie	Engranaje conducido
09 Distanzbuchse	Spacer	Distanziatore	Bague de réduction	Espaciador
10 Distanzscheibe	Washer	Rondella	Rondelle	El apoyo a disco
11 Distanzscheibe	Washer	Rondella	Rondelle	El apoyo a disco
12 Kugellager	Bearing	Cuscinetto	Roulement à billes	Rodamiento de bolas
13 Kugellager	Bearing	Cuscinetto	Roulement à billes	Rodamiento de bolas
14 Kugellager	Bearing	Cuscinetto	Roulement à billes	Rodamiento de bolas
15 Kugellager	Bearing	Cuscinetto	Roulement à billes	Rodamiento de bolas
16 Öldichtung	Oil Seal	Paraolio	Joint Huile	Sello de aceite
17 Ölbedeckung	Oil Cover	Tappo di chiusura	Couverture d'huile	Tapón de cierre
18 Sicherungsring (DIN 472)	Circlip (DIN 472)	Anello di sicurezza (DIN 472)	Circlip (DIN 472)	Anillo de seguridad (DIN 472)
19 Sicherungsring (DIN 472)	Circlip (DIN 472)	Anello di sicurezza (DIN 472)	Circlip (DIN 472)	Anillo de seguridad (DIN 472)
20 Sicherungsring (DIN 471)	Circlip (DIN 471)	Anello di sicurezza (DIN 471)	Circlip (DIN 472)	Anillo de seguridad (DIN 471)
21 Passscheibe (DIN 988)	Shim (DIN 988)	Shim (DIN 988)	Rondelle d'ajustage (DIN 988)	Calce (DIN 988)
22 Passscheibe (DIN 988)	Shim (DIN 988)	Shim (DIN 988)	Rondelle d'ajustage (DIN 988)	Calce (DIN 988)
23 Passfeder (DIN 6885)	Key (DIN 6885)	Chiavetta (DIN 6885)	Clavette (DIN 6885)	Clave (DIN 6885)
24 Passfeder (DIN 6885)	Key (DIN 6885)	Chiavetta (DIN 6885)	Clavette (DIN 6885)	Clave (DIN 6885)
25 Passfeder (DIN 6885)	Key (DIN 6885)	Chiavetta (DIN 6885)	Clavette (DIN 6885)	Clave (DIN 6885)
26 Verschrauben (DIN 933)	Bolt (DIN 933)	Bullone (DIN 933)	Boulonner (DIN 933)	Atornillar (DIN 933)
27 Distanzscheibe (DIN 7603)	Washer (DIN 7603)	Rondella (DIN 7603)	Rondelle (DIN 7603)	El apoyo a disco (DIN 7603)
28 Ölstopf (DIN 908)	Oil Plug (DIN 908)	Oljo Tappo (DIN 908)	Bouchon d'huile (DIN 908)	Tapón (DIN 908)
29 Antriebsritzel	Driving Pinion	Ingresso Pignone	Engrenage Z1	Piñón de entrada
30 Antriebsritzel (Mit Passfeder)	Driving Pinion (With Key)	Ingresso Pignone (Con chiavetta)	Engrenage Z1 (Avec clavette)	Piñón de entrada (Con clave)
31 Sicherungsring (DIN 471)	Circlip (DIN 471)	Anello di sicurezza (DIN 471)	Circlip (DIN 471)	Anillo de seguridad (DIN 471)
32 Passfeder (DIN 6885)	Key (DIN 6885)	Chiavetta (DIN 6885)	Clavette (DIN 6885)	Clave (DIN 6885)

DE ALLGEMEINE TEILELISTE

EN GENERAL PART LIST

IT GENERALE ELENCO DELLE PARTI

FR GÉNÉRALE LA LISTE DES PIÈCES

ES LISTE DE PIEZAS EN GENERAL

AF / F 301 ... 701 / 252 ... 902 / 253 ... 903 - B5

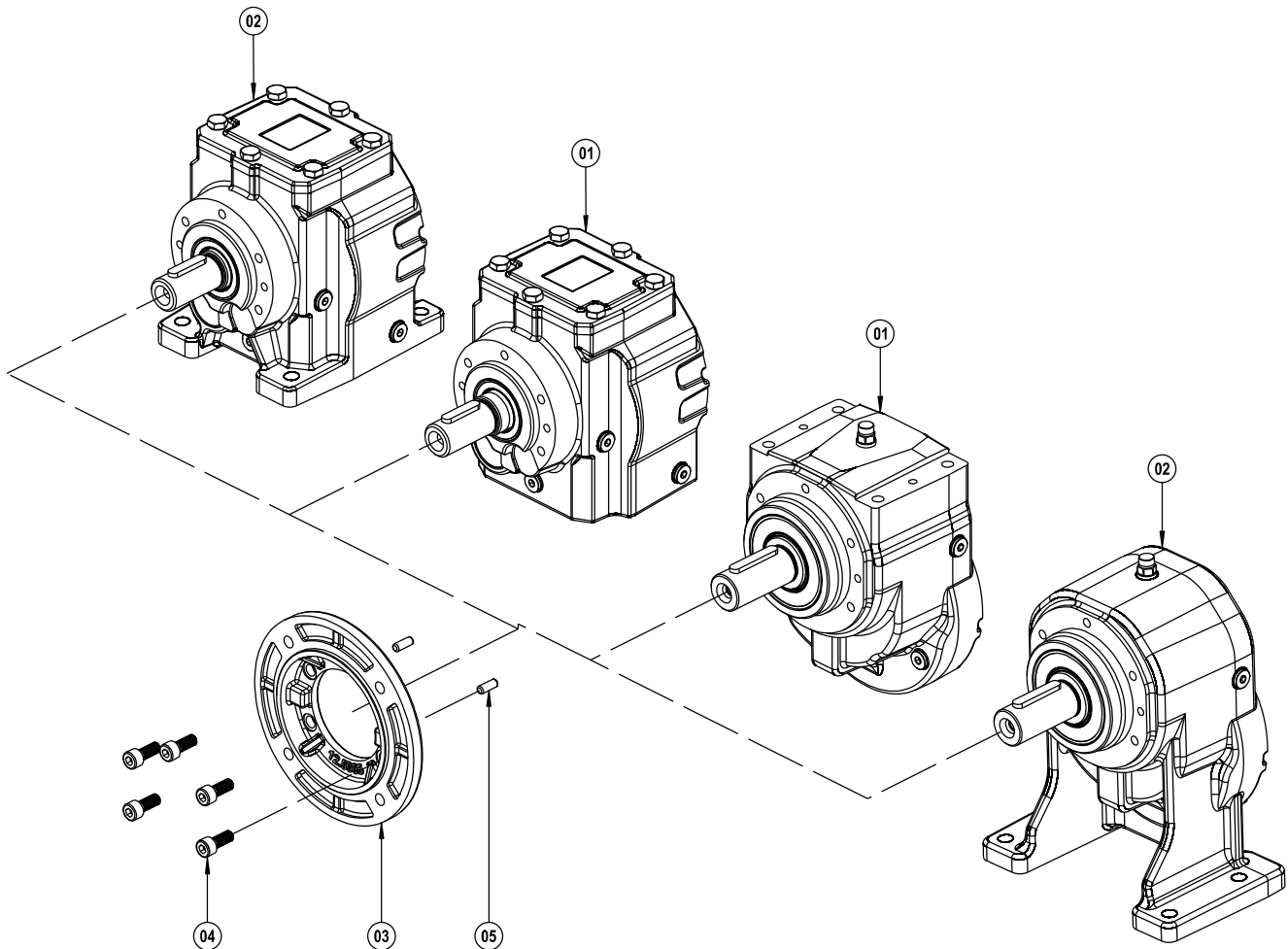

- 01 F Bausatz
- 02 AF Bausatz
- 03 B5 Abtriebsflansch
- 04 Verschrauben (DIN 912)
- 05 Bolzen

- F Kit
- AF Kit
- B5 Output Flange
- Bolt (DIN 912)
- Pin

- F Kit
- AF Kit
- B5 Flangia d'uscita
- Bullone (DIN 912)
- Pin

- F Kit
- AF Kit
- B5 Bride sortie
- Boulonner (DIN 912)
- Goupille

- F Kit
- AF Kit
- B5 Brida de solida
- Atornillar (DIN 912)
- Pasador