

DE PRODUKTE
FR PRODUITS

EN PRODUCTS
ES PRODUCTOS

IT PRODOTTI

A... / MOTOR

Fußbefestigung / Foot mounting / Fissaggio piede /
Fixation à pattes / Fijación por patas

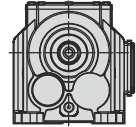
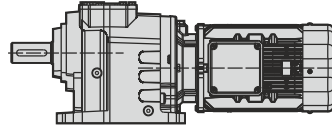

A... / PAM

Fußbefestigung / Foot mounting / Fissaggio piede /
Fixation à pattes / Fijación por patas

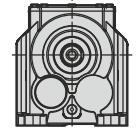
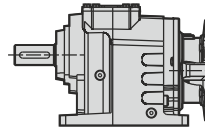

A... / W

Fußbefestigung / Foot mounting / Fissaggio piede /
Fixation à pattes / Fijación por patas

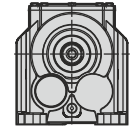
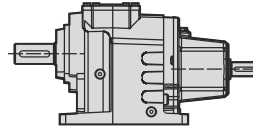

F... / MOTOR

Flanschbefestigung / Flange mounting / Fissaggio flangia /
Fixation à bride / Fijación por brida

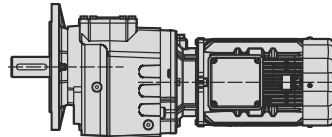

F... / PAM

Flanschbefestigung / Flange mounting / Fissaggio flangia /
Fixation à bride / Fijación por brida

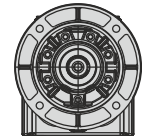
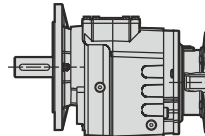

F... / W

Flanschbefestigung / Flange mounting / Fissaggio flangia /
Fixation à bride / Fijación por brida

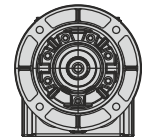
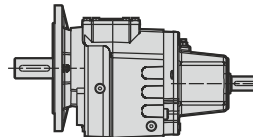

AF... / MOTOR

Fuß-Flanschbefestigung / Foot-flange mounting / Fissaggio piede-flangia
Fixation à paaes et bride / Fijación patas-brida

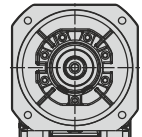
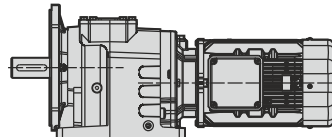

AF... / PAM

Fuß-Flanschbefestigung / Foot-flange mounting / Fissaggio piede-flangia
Fixation à paaes et bride / Fijación patas-brida

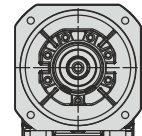
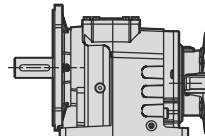

AF... / W

Fuß-Flanschbefestigung / Foot-flange mounting / Fissaggio piede-flangia
Fixation à paaes et bride / Fijación patas-brida

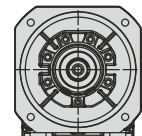
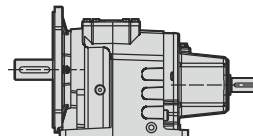

Typ / Type / Tipo Type / Tipo	l _{ges}	4-pol 50Hz 1400rpm n ₂ [min ⁻¹]	M _{amax} f _B =1 4 - pol. [Nm]	W			IEC - PAM								
				P _{1max} 4 - pol. 1400 rpm [kW]	FR1 [kN]	FR2 (a) [kN]	f _B ⇨ 49 - 112								
A403	267.75	5.2	850	0.47	2.8	12.0	71	80*	90*						
F403	234.50	6.0	850	0.53	2.8	12.0	71	80*	90*						
W	215.01	6.5	850	0.58	2.8	12.0	71	80*	90*						
	186.14	7.5	850	0.67	2.7	12.0	71	80*	90*	100*	112*				
131	170.55	8.2	850	0.73	2.7	12.0	71	80*	90*						
+	149.47	9.4	850	0.83	2.7	12.0	71	80	90*	100*	112*				
PAM - IEC	135.37	10.3	850	0.92	2.7	12.0	71	80	90*	100*	112*				
	118.13	11.9	850	1.05	2.7	12.0	71	80	90*	100*	112*				
131	94.86	14.8	850	1.31	2.7	12.0	71	80	90*	100*	112*				
	85.91	16.3	850	1.45	2.6	12.0	71	80	90*	100*	112*				
	68.25	20.5	850	1.83	2.6	12.0		80	90	100*	112*				
	54.81	25.5	850	2.27	2.5	12.0		80	90	100*	112*				
	49.64	28.2	850	2.51	2.5	12.0		80	90	100*	112*				
A402	45.38	30.9	850	2.75	2.4	12.0	80	90	100*	112*					
F402	39.72	35.2	850	3.14	2.4	12.0	80	90	100	112*					
W	36.44	38.4	800	3.22	2.4	12.0	80	90	100	112*					
	31.50	44.4	850	3.96	2.3	12.0	80	90	100	112*	132*				
131	28.89	48.5	800	4.06	2.3	12.0	80	90	100	112*					
+	25.30	55.3	850	4.93	2.1	12.0	80	90	100	112	132*				
PAM - IEC	22.91	61.1	850	5.44	2.1	12.0	80	90	100	112	132*				
	19.94	70.2	850	6.25	1.9	11.7	80	90	100	112	132*				
131	17.37	80.6	830	7.00	1.8	11.1	80	90	100	112	132*				
	16.01	87.4	800	7.33	1.8	10.8	80	90	100	112	132*				
	14.50	96.6	700	7.08	1.8	10.9	80	90	100	112	132*				
	12.44	112.5	700	8.25	1.7	10.2			100	112	132*				
	11.46	122.2	650	8.32	1.7	10.1	80	90	100	112	132*				
	9.20	152.2	600	9.56	1.5	9.4	80	90	100	112	132				
	8.33	168.0	600	10.55	1.3	9.0	80	90	100	112	132				
	7.22	193.9	550	11.17	1.3	8.7	80	90	100	112	132				
	5.80	241.5	550	13.91	0.9	7.9	80	90	100	112	132				
	5.25	266.7	500	13.96	0.9	7.8	80	90	100	112	132				
A401	8.25	169.7	170	3.02	2.7	3.7	80	90	100	112*					
F401	7.22	193.8	170	3.45	2.6	3.7	80	90	100	112*					
W	5.73	244.4	170	4.35	2.5	3.4	80	90	100	112*					
	5.17	271.0	170	4.82	2.5	3.2	80	90	100	112					
129	4.69	298.4	160	5.00	2.5	3.1	80	90	100	112					
+	3.93	355.9	150	5.59	2.4	3.0	80	90	100	112					
PAM - IEC	3.63	386.2	150	6.07	2.4	2.9	80	90	100	112					
	3.11	450.0	130	6.13	2.4	2.8			100	112					
129	2.52	554.7	120	6.97	2.3	2.6	80	90	100	112					
	2.08	672.0	120	8.44	2.1	2.4	80	90	100	112					
	1.31	1066.7	80	8.94	2.1	2.2	80	90	100	112					

Keine IEC - PAM-Verbindung / No IEC - PAM assembling on empty fields / Nessun assemblaggio IEC - PAM su campi vuoti / Pas d'assemblage IEC - PAM sur champs vides / Sin montaje IEC - PAM en campos vacíos

63 IEC - PAM-Verbindung möglich / IEC - PAM assembling available on numbered fields / Montaggio IEC - PAM disponibile su campi numerati / Assemblage IEC - PAM disponible sur champs numérotés / Assemblage IEC - PAM disponible sur champs numérotés /

80* Bei IEC - PAM-Verbindungen, sollten die P_{1max}-Werte nicht überschritten werden / Do not exceed the P_{1max} values indicated on fields with asterisk / Non superare i valori P_{1max} indicati sui campi con l'asterisco / Ne pas dépasser les valeurs P_{1max} indiquées sur les champs avec astérisque / No exceda los valores de P_{1max} indicados en los campos con asterisco

A 402-403

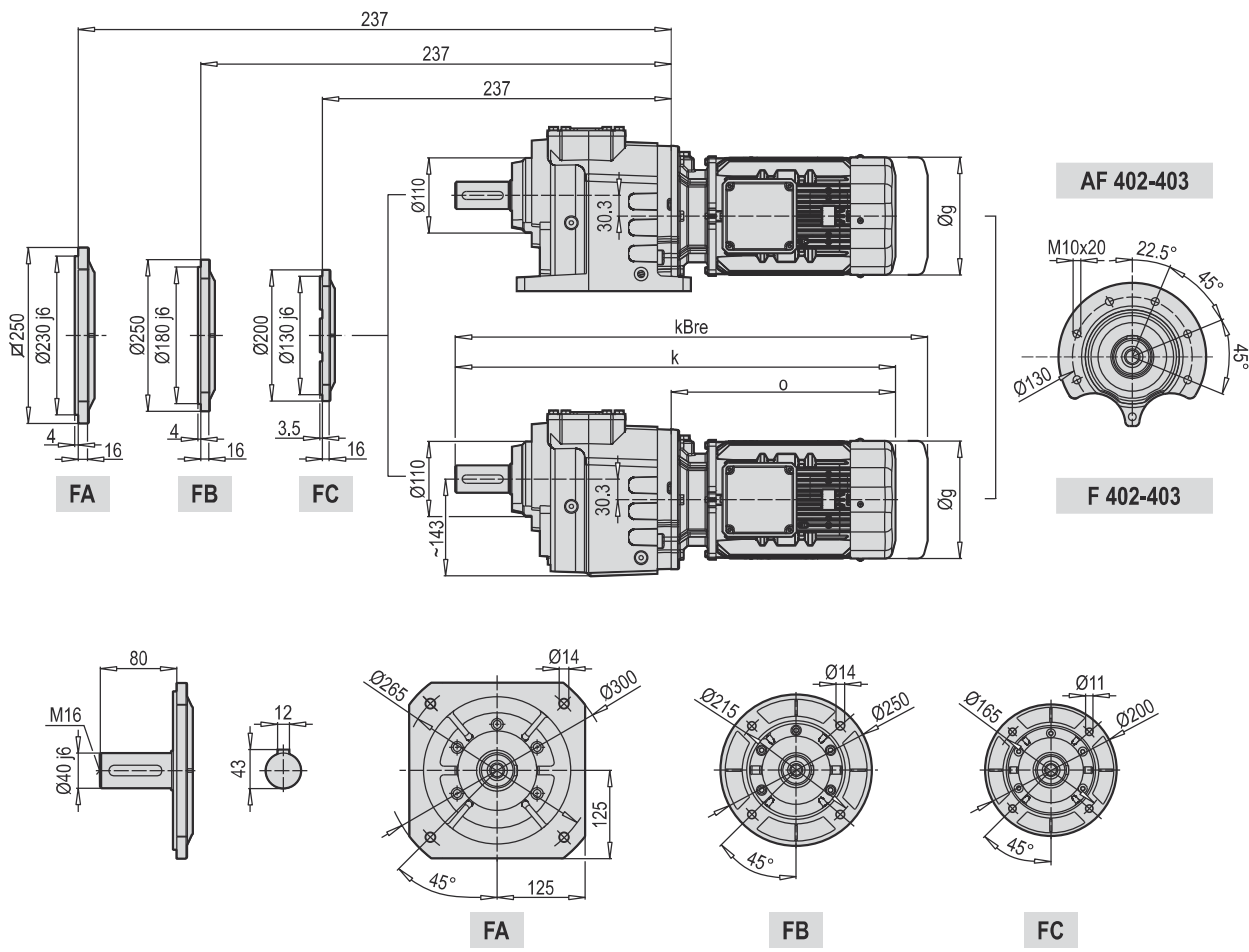
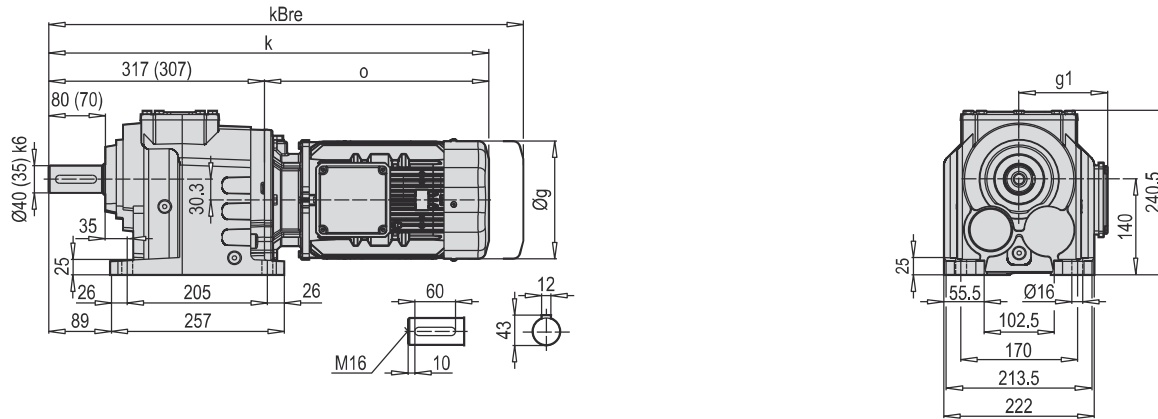

	71 M	80 M	90 S/L	100 L	112 M	132 S	132 M	
g	140	172	182	202	220	271	271	
g₁	119	131	130	153	159	188	188	
k	538 (528)	563 (553)	646 (636)	699 (689)	697 (687)	771 (761)	771 (761)	
k_{Bre}	598 (588)	634 (624)	714 (704)	783 (773)	798 (788)	870 (860)	890 (880)	
o	221	246	329	382	380	454	454	

A 402-403 PAM B5/B14

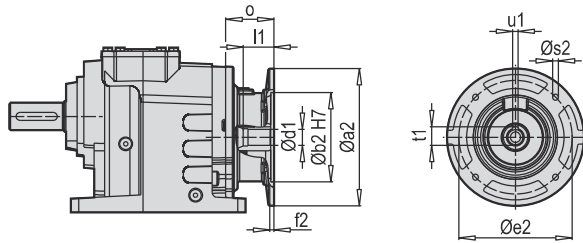

A 402-403 W

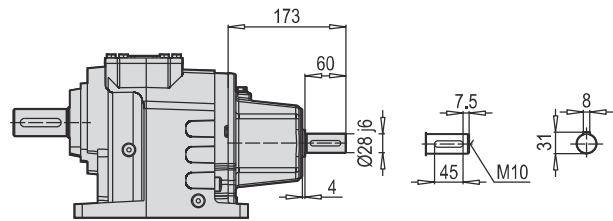

F 402-403 PAM B5/B14

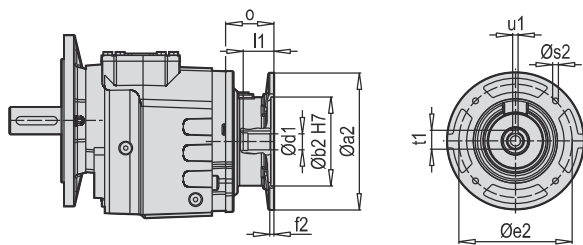

F 402-403 W

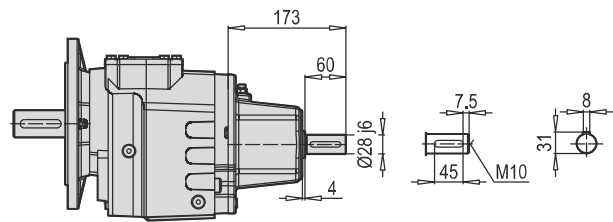

AF 402-403 PAM B5/B14

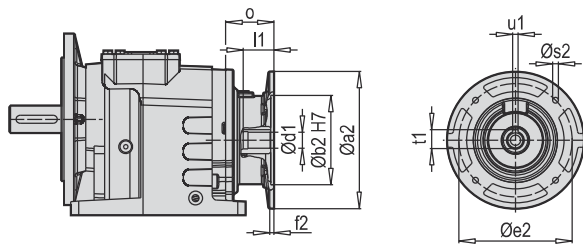

AF 402-403 W

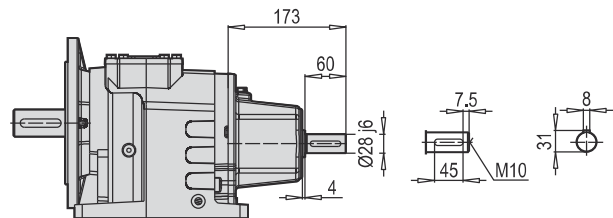

W ~ Kg	
A/F 402-403	37

Typ / Type / Tipo Type / Tipo	~ Kg										
	PAM B5	Øa2	Øb2	Øe2	f2	Øs2	Ød1	l1	t1	u1	o
A/F 402 A/F 403	71	160	110	130	5	M8	14	32	16.3	5	49
	80	200	130	165	5	M10	19	42	21.8	6	70
	90	200	130	165	5	M10	24	52	27.3	8	70
	100	250	180	215	5.5	M12	28	62	31.3	8	85
	112	250	180	215	5.5	M12	28	62	31.3	8	85
	132	300	230	265	5.5	M12	38	82	41.3	10	110

~ Kg	
PAM B5	A/F 402-403
71	32
80	35
90	35
100	37
112	37
132	41

Typ / Type / Tipo Type / Tipo	~ Kg										
	PAM B14	Øa2	Øb2	Øe2	f2	Øs2	Ød1	l1	t1	u1	o
A/F 402 A/F 403	71	105	70	85	2.5	7	14	32	16.3	5	49
	80	120	80	100	3	7	19	42	21.8	6	70
	90	140	95	115	3	9	24	52	27.3	8	70
	100	160	110	130	3.5	9	28	62	31.3	8	85
	112	160	110	130	3.5	9	28	62	31.3	8	85
	132	200	130	165	3.5	11	38	82	41.3	10	110

~ Kg	
PAM B14	A/F 402-403
71	30
80	31
90	31
100	32
112	32
132	38

DE ALLGEMEINE TEILELISTE

EN GENERAL PART LIST

IT GENERALE ELENCO DELLE PARTI

FR GÉNÉRALE LA LISTE DES PIÈCES

ES LISTE DE PIEZAS EN GENERAL

A / F / AF 252 ... 902

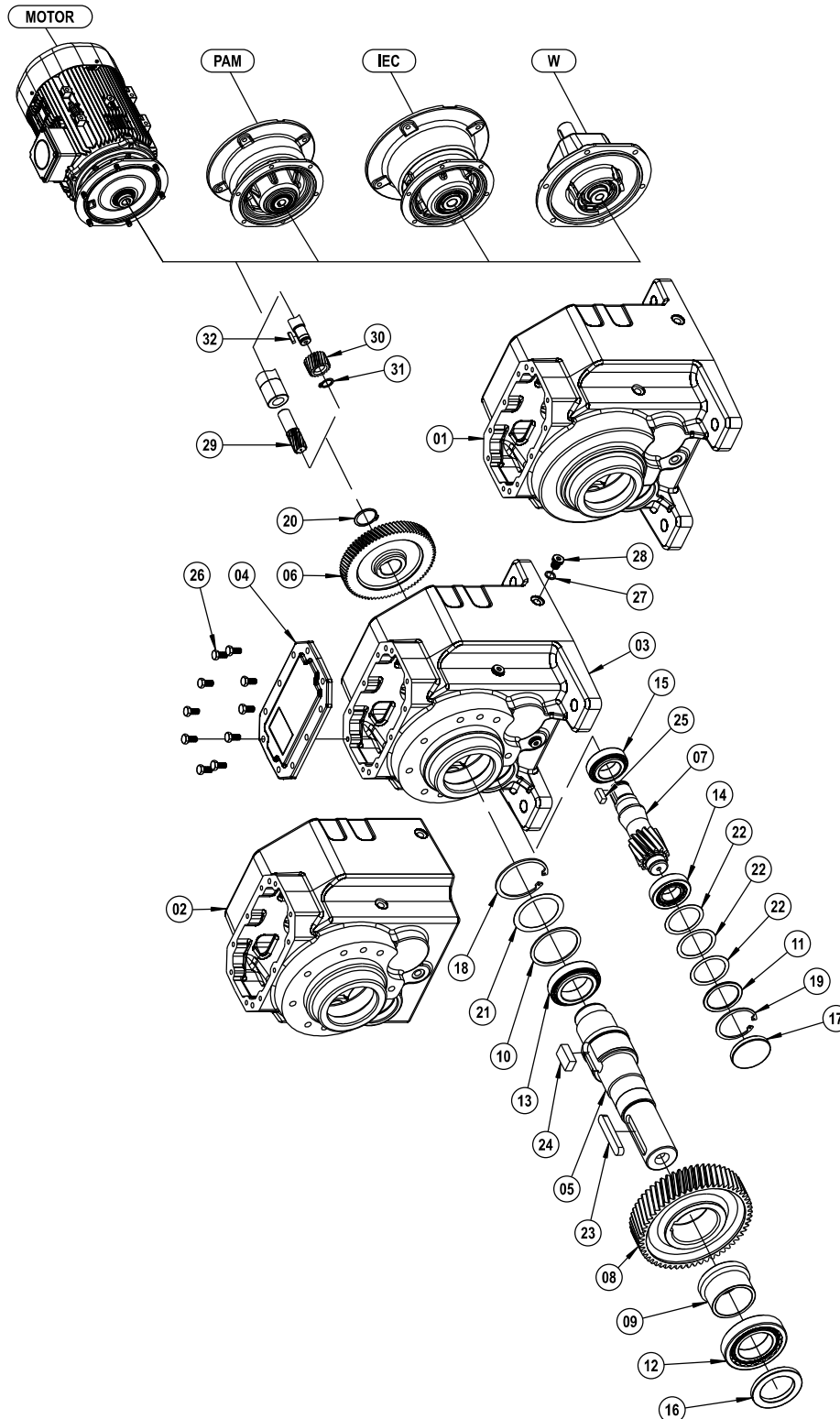

DE ALLGEMEINE TEILELISTE
FR GÉNÉRALE LA LISTE DES PIÈCES

EN GENERAL PART LIST
ES LISTE DE PIEZAS EN GENERAL

IT GENERALE ELENCO DELLE PARTI

01 A Gehäuse	A Gear Case	A Ingranaggi Box	A Corps	A La caja de engranajes
02 F Gehäuse	FGear Case	F Ingranaggi Box	F Corps	F La caja de engranajes
03 AF Gehäuse	AF Gear Case	AF Ingranaggi Box	AF Corps	AF La caja de engranajes
04 Abdeckung	Cover	Coperchio	Couverture	Cubierta
05 Abtriebswelle	Output Solid Shaft	Albero di uscita	Arbre de sortie	Eje de salida
06 Antriebsrad	Driving Gear	Ingranaggio Conduttore	Rove d'entrée	Engranaje con ducido
07 Ritzelwelle	Pinion Shaft	Pignone	Arbre intermédiaire	Deleje del piñón
08 Abtriebsrad	Driven Gear	Ingranaggio Condotto	Rove de sortie	Engranaje conducido
09 Distanzbuchse	Spacer	Distanziatore	Bague de réduction	Espaciador
10 Distanzscheibe	Washer	Rondella	Rondelle	El apoyo a disco
11 Distanzscheibe	Washer	Rondella	Rondelle	El apoyo a disco
12 Kugellager	Bearing	Cuscinetto	Roulement à billes	Rodamiento de bolas
13 Kugellager	Bearing	Cuscinetto	Roulement à billes	Rodamiento de bolas
14 Kugellager	Bearing	Cuscinetto	Roulement à billes	Rodamiento de bolas
15 Kugellager	Bearing	Cuscinetto	Roulement à billes	Rodamiento de bolas
16 Öldichtung	Oil Seal	Paraolio	Joint Huile	Sello de aceite
17 Ölbedeckung	Oil Cover	Tappo di chiusura	Couverture d'huile	Tapón de cierre
18 Sicherungsring (DIN 472)	Circlip (DIN 472)	Anello di sicurezza (DIN 472)	Circlip (DIN 472)	Anillo de seguridad (DIN 472)
19 Sicherungsring (DIN 472)	Circlip (DIN 472)	Anello di sicurezza (DIN 472)	Circlip (DIN 472)	Anillo de seguridad (DIN 472)
20 Sicherungsring (DIN 471)	Circlip (DIN 471)	Anello di sicurezza (DIN 471)	Circlip (DIN 472)	Anillo de seguridad (DIN 471)
21 Passscheibe (DIN 988)	Shim (DIN 988)	Shim (DIN 988)	Rondelle d'ajustage (DIN 988)	Calce (DIN 988)
22 Passscheibe (DIN 988)	Shim (DIN 988)	Shim (DIN 988)	Rondelle d'ajustage (DIN 988)	Calce (DIN 988)
23 Passfeder (DIN 6885)	Key (DIN 6885)	Chiavetta (DIN 6885)	Clavette (DIN 6885)	Clave (DIN 6885)
24 Passfeder (DIN 6885)	Key (DIN 6885)	Chiavetta (DIN 6885)	Clavette (DIN 6885)	Clave (DIN 6885)
25 Passfeder (DIN 6885)	Key (DIN 6885)	Chiavetta (DIN 6885)	Clavette (DIN 6885)	Clave (DIN 6885)
26 Verschrauben (DIN 933)	Bolt (DIN 933)	Bullone (DIN 933)	Boulonner (DIN 933)	Atornillar (DIN 933)
27 Distanzscheibe (DIN 7603)	Washer (DIN 7603)	Rondella (DIN 7603)	Rondelle (DIN 7603)	El apoyo a disco (DIN 7603)
28 Ölstopf (DIN 908)	Oil Plug (DIN 908)	Oljo Tappo (DIN 908)	Bouchon d'huile (DIN 908)	Tapón (DIN 908)
29 Antriebsritzel	Driving Pinion	Ingresso Pignone	Engrenage Z1	Piñón de entrada
30 Antriebsritzel (Mit Passfeder)	Driving Pinion (With Key)	Ingresso Pignone (Con chiavetta)	Engrenage Z1 (Avec clavette)	Piñón de entrada (Con clave)
31 Sicherungsring (DIN 471)	Circlip (DIN 471)	Anello di sicurezza (DIN 471)	Circlip (DIN 471)	Anillo de seguridad (DIN 471)
32 Passfeder (DIN 6885)	Key (DIN 6885)	Chiavetta (DIN 6885)	Clavette (DIN 6885)	Clave (DIN 6885)

DE ALLGEMEINE TEILELISTE

EN GENERAL PART LIST

IT GENERALE ELENCO DELLE PARTI

FR GÉNÉRALE LA LISTE DES PIÈCES

ES LISTE DE PIEZAS EN GENERAL

AF / F 301 ... 701 / 252 ... 902 / 253 ... 903 - B5

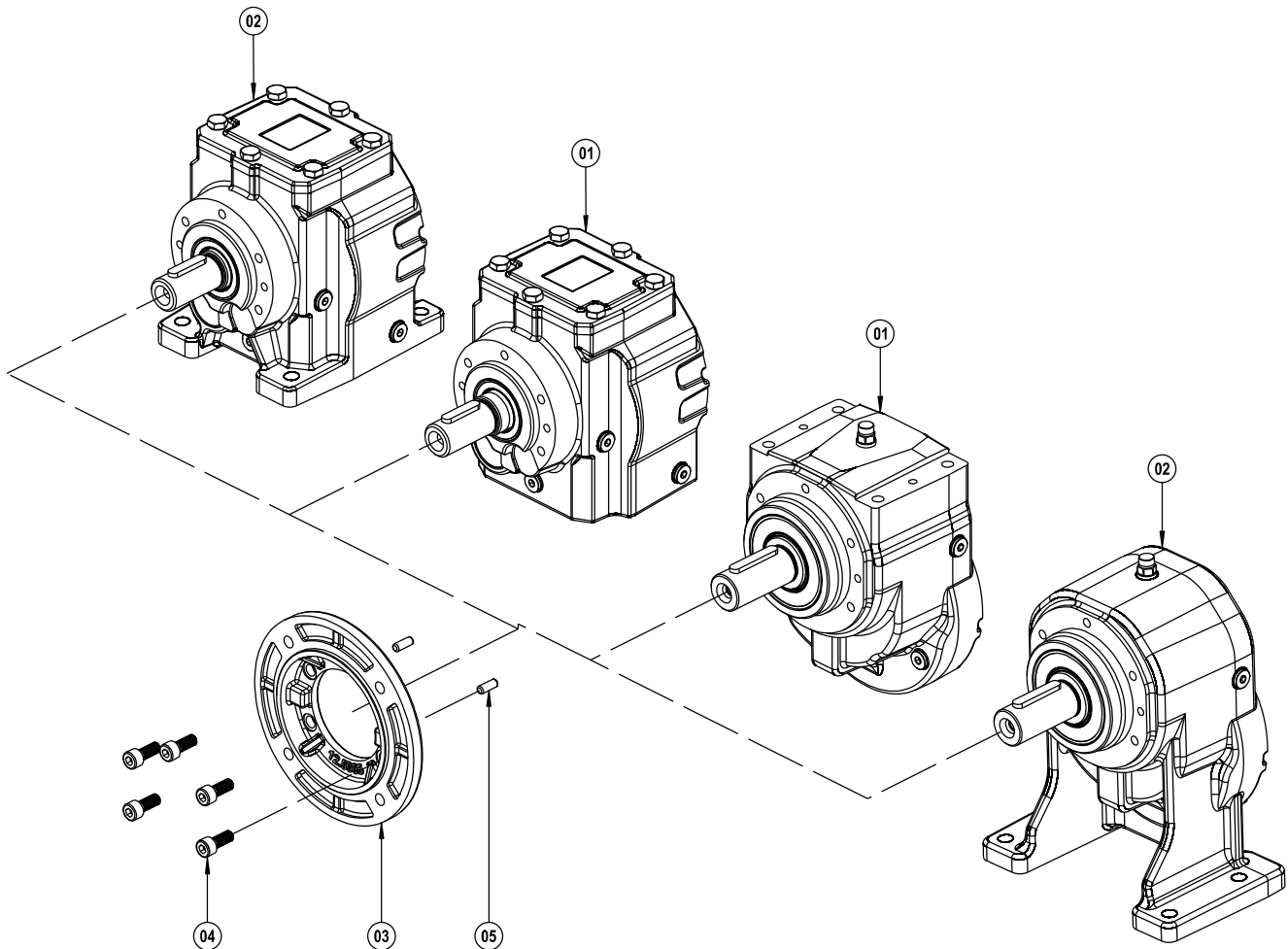

- 01 F Bausatz
- 02 AF Bausatz
- 03 B5 Abtriebsflansch
- 04 Verschrauben (DIN 912)
- 05 Bolzen

- F Kit
- AF Kit
- B5 Output Flange
- Bolt (DIN 912)
- Pin

- F Kit
- AF Kit
- B5 Flangia d'uscita
- Bullone (DIN 912)
- Pin

- F Kit
- AF Kit
- B5 Bride sortie
- Boulonner (DIN 912)
- Goupille

- F Kit
- AF Kit
- B5 Brida de solida
- Atornillar (DIN 912)
- Pasador